

# SINEAX G536

## Phase Angle or Power Factor Transducer

Carrying rail housing P13/70



### Application

The transducer **SINEAX G536** (Fig. 1) measures the phase angle or power factor between current and voltage of a single or 3-phase balanced network having a sine wave form.

The output signal, in the form of a **load independent** DC current or voltage, is proportional to the phase angle resp. power factor between the 2 measured quantities current and voltage.

The transducer fulfils all the important requirements and regulations concerning electromagnetic compatibility **EMV** and **Safety** (IEC 1010 resp. EN 61 010). It was developed and is manufactured and tested in strict accordance with the **quality assurance standard** ISO 9001.



Fig. 1. Transducer SINEAX G536 in housing P13/70 clipped onto a top-hat rail.

### Features / Benefits

- **Measuring input:** Sine, rectangular or distorted wave forms of input quantities with dominant fundamental wave

Measured variables	Nominal input current	Nominal input voltage	Measuring range limits
Phase angle or power factor	0.5 to 6 A	10 to 690 V	Min. span 20 °el Max. span 360 °el

- **Measuring output:** Unipolar, bipolar or live zero output variables
- **Measuring principle:** Measurement of the zero crossing interval
- AC/DC power supply / Universal
- Standard as marine version per Lloyd's Register of Shipping

### Technical data

#### General

Measured quantity: Phase angle or power factor between current and voltage

Measuring principle: Measurement of the zero crossing interval

### Measuring input

Examples of measuring ranges with  $\varphi$ -linear output

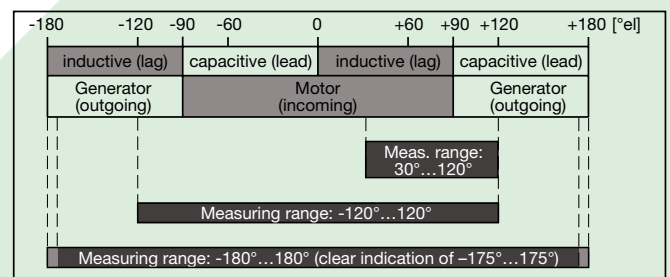

Examples of measuring ranges with  $\cos\varphi$ -linear output

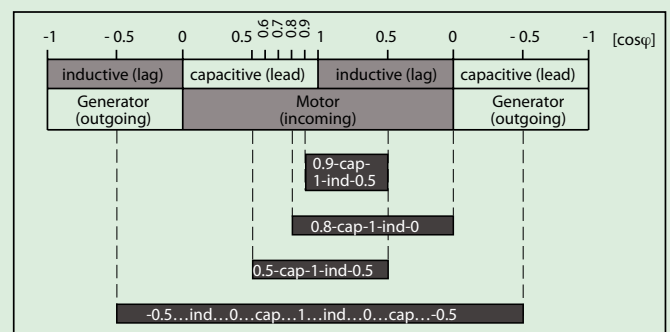

Nominal frequency  $f_N$ : 16 2/3 ... 400 Hz

# SINEAX G536

## Phase Angle or Power Factor Transducer

Nominal input voltage  $U_N$ : 10 ... 690 V  
(max. 230 V with power supply from voltage measuring input)

Response sensitivity: 10 ... 120%  $U_N$

Nominal input current  $I_N$ :  $\geq 0.5$  to 6.0 A

Response sensitivity:  $< 1\%$   $I_N$

Own consumption:  $< 0.1$  VA per current path  
 $U_N \cdot 1.5$  mA per voltage path

Overload capacity:

Input variables $I_N, U_N$	Number of applications	Duration of one application	Interval between two successive applications
$1.2 \times I_N$	—	continuously	—
$20 \times I_N$	10	1 s	100 s
$1.2 \times U_N^1$	—	continuously	—
$2 \times U_N^1$	10	1 s	10 s

<sup>1</sup> But max. 264 V with power supply from voltage measurement

### Measuring output $\rightarrow$

Load-independent DC current: 0 ... 1 to 0 ... 20 mA resp. live-zero  
1 ... 5 to 4 ... 20 mA  
 $\pm 1$  to  $\pm 20$  mA

Burden voltage: + 15 V, resp. - 12 V

Load-independent DC voltage: 0 ... 1 to 0 ... 10 V resp. live-zero  
0.2 ... 1 to 2 ... 10 V  
 $\pm 1$  to  $\pm 10$  V

Load capacity: Max. 4 mA

Voltage limit under  $R_{ext} = \infty$ :  $\leq 25$  V

Current limit under overload: Approx. 30 mA

Residual ripple in output current:  $< 0.5\%$  p.p.

Nominal value of response time: 4 periods of the nominal frequency

Other ranges: 2, 8 or 16 periods of the nominal frequency

### Output characteristic

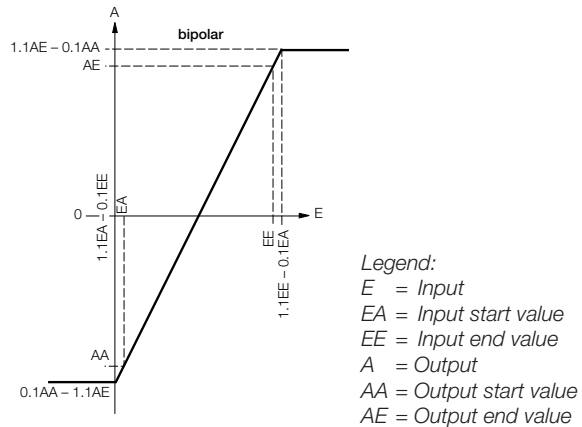
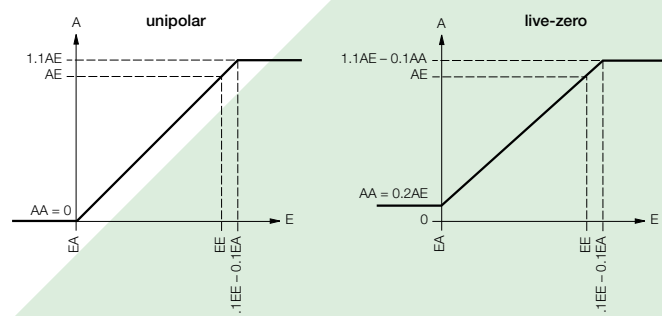

### Accuracy (acc. to EN 60 688)

Reference value:  $\Delta\varphi = 90^\circ$  resp.  $\Delta\cos\varphi = 0.5$

Basic accuracy: Class 0.5

### Reference conditions

Ambient temperature: 15 ... 30 °C  
Input current: 0.8 ... 1.2  $I_N$   
Input voltage: 0.8 ... 1.2  $U_N$   
Frequency:  $f_N \pm 10\%$   
Wave forms: Sine wave  
Power supply: At nominal range  
Output burden:  $\Delta R_{ext}$  max.

### Additional errors (maxima):

Voltage influence between 0.5 and 1.5  $U_N$ :  $\pm 0.3\%$   
Current influence between 0.4 and 1.5  $I_N$ :  $\pm 0.3\%$   
between 0.1 and 1.5  $I_N$ :  $\pm 0.5\%$

### Safety

Protection class: II (protection isolated, EN 61 010)  
Housing protection: IP 40, housing (test wire, EN 60 529)  
IP 20, terminals (test finger, EN 60 529)

Contamination level: 2

Overvoltage category: III

Rated insulation voltage (against earth): 230 V resp. 400 V, inputs  
230 V, power supply  
40 V, output

Test voltage: 50 Hz, 1 min. acc. to EN 61 010-1  
3700 resp. 5550 V, inputs versus all other circuits as well as outer surface

## Phase Angle or Power Factor Transducer

Test voltage  
(continuation):

3250 V, input circuits versus each other

3700 V, power supply versus output as well as outer surface

490 V, output versus outer surface

Permissible cross section  
of the connection leads:

≤ 4.0 mm<sup>2</sup> single wire or  
2 x 2.5 mm<sup>2</sup> fine wire

### Power supply →○

AC/DC power pack (DC or 50/60 Hz)

Table 1: Rated voltages and permissible variations

Rated voltage	Tolerance
85 ... 230 V DC, AC	DC – 15 ... + 33%
24 ... 60 V DC, AC	AC ± 15%

or

Power supply from  
voltage measuring input: 24...60 V AC or 85...230 V AC

Option: Connect to the low tension to terminals 12 and 13  
24 V AC or 24 ... 60 V DC

Power consumption: 3 VA

### Installation data

Mechanical design: Housing **P13/70**

Material of housing: Lexan 940 (polycarbonate),  
flammability Class V-0 acc. to UL 94,  
self-extinguishing, non-dripping,  
free of halogen

Mounting: For rail mounting

Mounting position: Any

Weight: Approx. 0.24 kg

### Connecting terminals

Connection element: Screw-type terminals with indirect  
wire pressure

### Environmental conditions

Operating temperature: – 10 to + 55 °C

Storage temperature: – 40 to + 70 °C

Relative humidity: ≤ 75%, no dew

Altitude: 2000 m max.

Indoor use statement!

### Ambient tests

EN 60 068-2-6: Vibration

Acceleration: ± 2 g

Frequency range: 10 ... 150 ... 10 Hz, rate of frequency  
sweep: 1 octave/minute

Number of cycles: 10, in each of the three axes

EN 60 068-2-27: Shock

Acceleration: 3 x 50  
3 shocks each in 6 directions

EN 60 068-2-1/-2/-3: Cold, dry heat, damp heat

IEC 1000-4-2/-3/-4/-5/-6

EN 55 011: Electromagnetic compatibility

### Germanischer Lloyd

Type approval certificate: No. 12 261-98 HH

Ambient category: C

Vibration: 0.7 g

Table 2: Specification and ordering information

Description	*Blocking code	no-go with blocking code	Article No./ Feature
<b>SINEAX G536</b>	<b>Order Code 536 - xxxx xxxx xx</b>		536 –
<b>Features, Selection</b>			
<b>1. Mechanical design</b> Housing P13/70 for rail mounting			4
<b>2. Measuring mode</b> For phase angle ( $\varphi$ -linear)	A		1
For power factor ( $\cos\varphi$ -linear)	B		2

# SINEAX G536

## Phase Angle or Power Factor Transducer

Description	*Blocking code	no-go with blocking code	Article No./ Feature
<b>SINEAX G536</b> <span style="float: right;"><b>Order Code 536 - xxxx xxxx xx</b></span>			536 –
<b>Features, Selection</b>			
<b>3. Application</b>			
Single-phase AC			1
U: L1 & L2    I: L1    3 or 4-wire 3-phase balanced load			2
U: L2 & L3    I: L2    3 or 4-wire 3-phase balanced load			3
U: L3 & L1    I: L3    3 or 4-wire 3-phase balanced load			4
U: L1 & L3    I: L1    3 or 4-wire 3-phase balanced load			5
U: L2 & L1    I: L2    3 or 4-wire 3-phase balanced load			6
U: L3 & L2    I: L3    3 or 4-wire 3-phase balanced load			7
U: L1 & L2    I: L3    3 or 4-wire 3-phase balanced load			A
U: L2 & L3    I: L1    3 or 4-wire 3-phase balanced load			B
U: L3 & L1    I: L2    3 or 4-wire 3-phase balanced load			C
<b>4. Nominal input frequency</b>			
50 Hz			1
60 Hz			2
Non-standard [Hz]			9
≥ 10 to 400 Hz			
With power supply from measuring input min. 40 Hz			
<b>5. Nominal input voltage</b>			
$U_N = 100\text{ V}$		C	1
$U_N = 230\text{ V}$		C	2
$U_N = 400\text{ V}$		D	3
Non-standard [V]			9
≥ 10 to 690 V			
With power supply from measuring input min. 24 V, max. 230 V, see feature 9, lines 3 and 4			
3-phase system: Input voltage = phase to phase voltage			
<b>6. Nominal input current</b>			
1 A			1
5 A			2
Non-standard [A]			9
≥ 0.5 to 6.0 A			
<b>7. Measuring range</b>			
Phase angle – 60 ... 0 ... + 60 °el		B	1
$\cos\varphi$ 0.5 ... cap ... 1 ... ind ... 0.5		A	2
Non-standard [°el] or [cosφ]			9
Measuring range within – 180 ... 0 ... + 180 °el or – 1 ... ind ... 0 ... cap ... 1 ... ind ... 0 ... cap ... – 1, but clear indication only to – 175 ... 0 ... + 175 °el			
Measuring span ≥ 20 °el			
<b>8. Output signal</b>			
0 ... 20 mA			1
4 ... 20 mA			2
Non-standard 0 ... 1.00 to 0 ... < 20, – 1.00 ... 0 ... 1.00 to – 20 ... 0 ... 20 (symmetrical) [mA]			9
1 ... 5 to < (4 ... 20) (AA / AE = 1 / 5)			
0 ... 10 V			A
Non-standard 0 ... 1.00 to 0 ... < 10, – 1.00 ... 0 ... 1.00 to – 10 ... 0 ... 10 (symmetrical) [V]			Z
0.2 ... 1 to 2 ... 10 (AA / AE = 1 / 5)			
AA = Output start value, AE = Output end value			

# SINEAX G536

## Phase Angle or Power Factor Transducer

Description	*Blocking code	no-go with blocking code	Article No./ Feature
<b>SINEAX G536</b>	<b>Order Code 536 - xxxx xxxx xx</b>		536 –
<b>Features, Selection</b>			
<b>9. Power supply</b>			
85 ... 230 V DC, AC			1
24 ... 60 V DC, AC			2
Internal from measuring input (24 ... 60 V AC)		C	3
Internal from measuring input (85 ... 230 V AC)		CD	4
Connect to the low tension 24 V AC / 24 ... 60 V DC			5
<b>10. Response time</b>			
4 periods of the input frequency (standard)			1
2 periods of the input frequency			2
8 periods of the input frequency			3
16 periods of the input frequency			4

\* Lines with letter(s) under "no-go" cannot be combined with preceding lines having the same letter under "SCODE".

### Application notes

Current connection in phase	L1	L2	L3	L1	L2	L3
Voltage connection between	L1 & L2	L2 & L3	L3 & L1	L1 & L3	L2 & L1	L3 & L2
Vector diagrams						

Current connection in phase	L3	L1	L2	L
Voltage connection between	L1 & L2	L2 & L3	L3 & L1	L & N
Vector diagrams				

# SINEAX G536

## Phase Angle or Power Factor Transducer

### Electrical connections

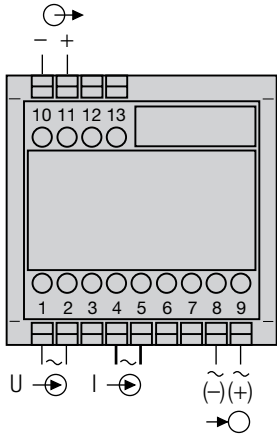

Fig. 2. Power supply connected to terminals 8 and 9.

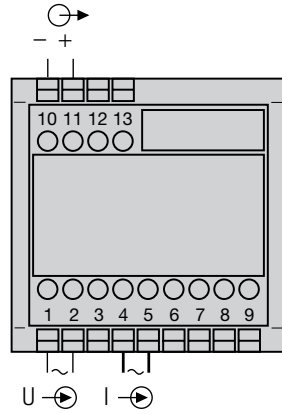

Fig. 3. Power supply internal from measuring input, without separated power supply.

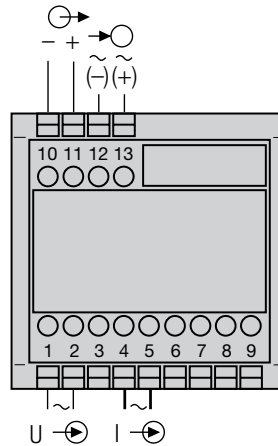

Fig. 4. Power supply connected to the low tension terminal side 12 and 13.

- = Measuring input
- = Measuring output
- = Power supply

Measuring inputs			
Application	Terminal allocation	Application	Terminal allocation
Phase angle or power factor measurement in single-phase AC network		Phase angle or power factor measurement in 3 or 4-wire 3-phase network U: L1 & L2 I: L1	
Phase angle or power factor measurement in 3 or 4-wire 3-phase network U: L2 & L3 I: L2		Phase angle or power factor measurement in 3 or 4-wire 3-phase network U: L3 & L1 I: L3	
Phase angle or power factor measurement in 3 or 4-wire 3-phase network U: L1 & L3 I: L1		Phase angle or power factor measurement in 3 or 4-wire 3-phase network U: L2 & L1 I: L2	
Phase angle or power factor measurement in 3 or 4-wire 3-phase network U: L3 & L2 I: L3		Phase angle or power factor measurement in 3 or 4-wire 3-phase network U: L1 & L2 I: L3	

# SINEAX G536

## Phase Angle or Power Factor Transducer

Measuring inputs			
Application	Terminal allocation	Application	Terminal allocation
Phase angle or power factor measurement in 3 or 4-wire 3-phase network U: L2 & L3 I: L1		Phase angle or power factor measurement in 3 or 4-wire 3-phase network U: L3 & L1 I: L2	

### Dimensional drawing

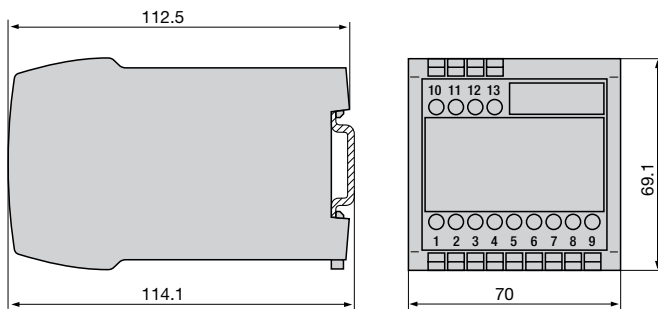

Fig. 5. Housing **P13/70** clipped onto a top-hat rail (35 x 15 or 35 x 7.5 mm, acc. to EN 50 022).

### Standard accessories

1 Operating instructions in three languages: German, French, English

**CAMILLE BAUER**

**Rely on us.**

Camille Bauer Ltd.  
 Aargauerstrasse 7  
 CH-5610 Wohlen / Switzerland  
 Phone: +41 56 618 21 11  
 Fax: +41 56 618 21 21  
[info@camillebauer.com](mailto:info@camillebauer.com)  
[www.camillebauer.com](http://www.camillebauer.com)