

11-3

고정식 단자대 Fixing Terminal Block

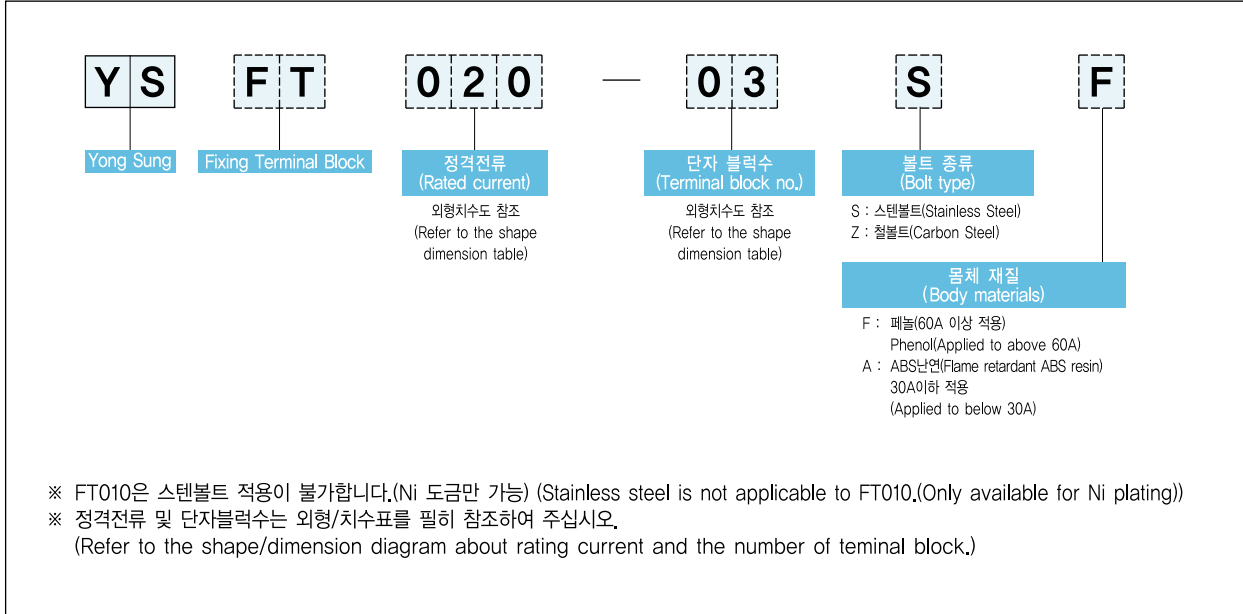

형식 구분도 | Type Classification Diagram



특징 | Features

- 고정식 단자를 10A~600A까지 개발하여 제품의 질을 높이고 작업에 불편한 점을 개선하여 커버에도 훅크 Pin을 부착하였고 투명도가 좋아 사용하기에 편리합니다.
- 최대 정격절연전압은 600V입니다.
- The development of fixing type terminals to 10A~600A increases the product quality and, hook pin is attached to cover in order to improve inconvenience at working and with good transparency it is convenient for use.
- Rating insulation voltage 600V is max.

▶ 단자대 커버 (Cover of terminal block)

투명재질로 만들어져 단자대에 표시한 번호판 문자의 식별이 보다 쉬워졌습니다.

With transparent materials, the letter distinction on number plate becomes easier.

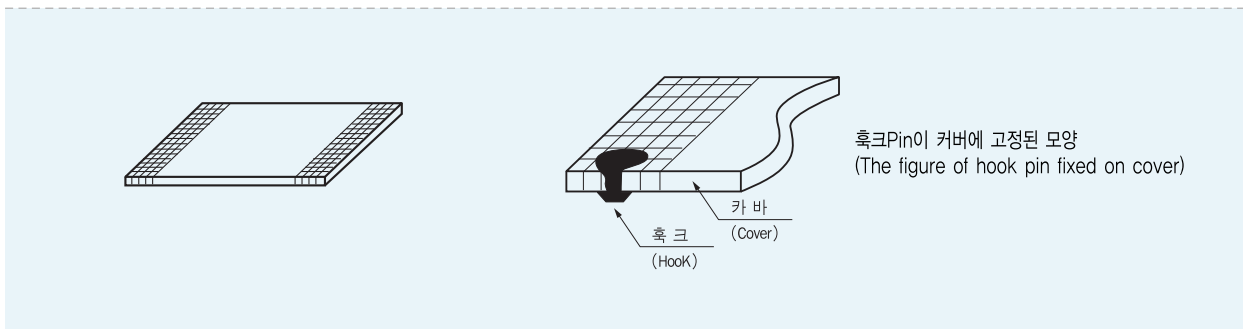

▶ **훅크 Pin (Hook pin)**

커버 고정핀으로 훅크타입으로 커버를 열고 닫기가 아주 편리할 뿐만 아니라 견고하게 부착되어 심한 진동에도 잘 견딜 수 있도록 용성 특유의 설계로 제작되었습니다.

As cover fixing pin, Yongsung makes with specific design so that this can be well durable with firm mounting even if serious vibration is applied as well as cover opening/closing is very convenient due to hook type.

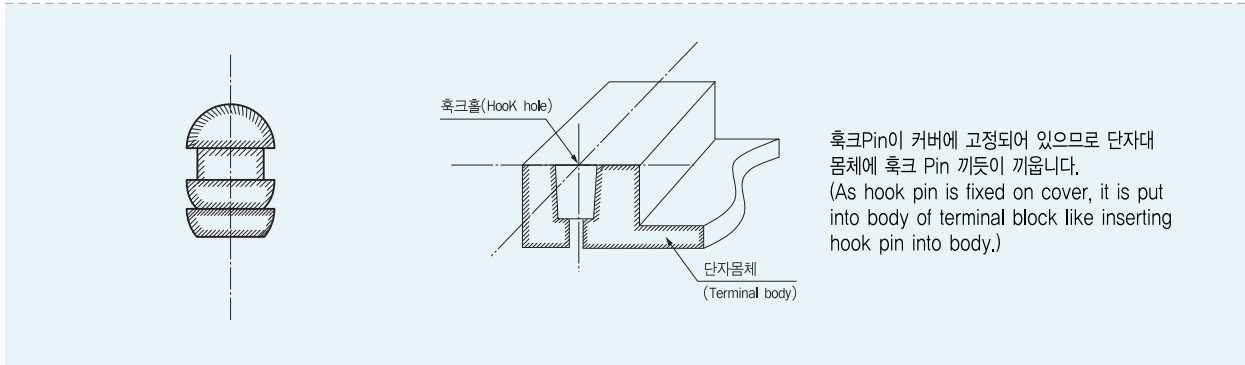

성능 개요 | Performance Summary |

정격절연전압 (Rated insulation voltage)	Max. 600V AC/DC
절연저항 (Insulation resistance)	100MΩ 이상 (Above 100MΩ) (DC 500V. Meg)
내전압 (Withstand voltage)	AC 2,500V/min (50/60Hz)
사용주위온도 (Ambient temperature)	-20°C ~ +55°C
상대습도 (Relative humidity)	45 ~ 85%

부품 재질 | Part Materials |

부품 (Part)	재질 (Materials)
몸체 (Body)	열경화성 페놀 수지, 난연 ABS (Thermosetting phenol resin, Flame retardant ABS resin)
단자 (Terminal)	황동 (Brass)
볼트 (Bolt)	탄소강 (Carbon steel) or 스테인레스 (Stainless steel)
커버 (Cover)	PS 수지 (PS resin) (15A~30A, 100A~300A) PC 수지 (PC resin) (60A, 400A 이상) (60A, above 400A)

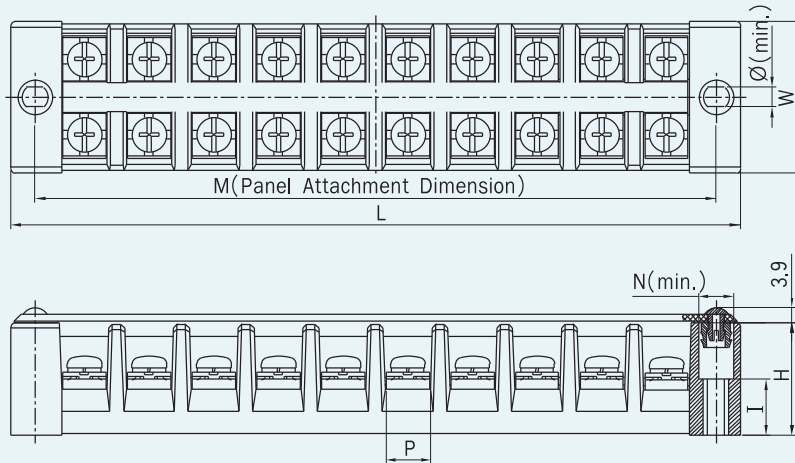

10A



형식(TYPE)	N(min)	L	W	I	H	P	Ø (min.)	M	적용적합전선 (Suitable Wire(max.))	단자볼트 (Terminal Bolt)	조임토크 (Torque)
YS FT010-02	Ø8.0	52	24	3.5	13	8.2	4.0	42	1~1.5mm ² (20~16AWG)	M3.5	8kgf·cm
YS FT010-03											

15A

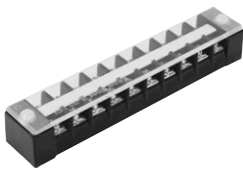

형식(TYPE)	N(min)	L	W	I	H	P	Ø (min.)	M	적용적합전선 (Suitable Wire(max.))	단자볼트 (Terminal Bolt)	조임토크 (Torque)
YS FT015-06	Ø8.0	87	24	5.0	19	8.7	4.0	76.5	1~2.5mm ² (18~14AWG)	M3.5	8kgf·cm
YS FT015-10		131						121.5			

20A

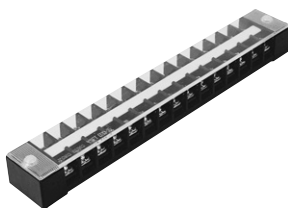

형식(TYPE)	N(min)	L	W	I	H	P	Ø (min.)	M	적용적합전선 (Suitable Wire(max.))	단자볼트 (Terminal Bolt)	조임토크 (Torque)
YS FT020-03	Ø8.0	56	30.2	5.0	19	8.7	4.0	45	1~2.5mm ² (18~14AWG)	M4.0	12kgf·cm
YS FT020-04		67						56			
YS FT020-06		89						78			
YS FT020-10		136						124.5			
YS FT020-12		162						150.5			
YS FT020-15		200						188			
YS FT020-20		257						245			

30A



CE

형식(TYPE)	N(min)	L	W	I	H	P	∅ (min.)	M	적용적합전선 (Suitable Wire(max.))	단자볼트 (Terminal Bolt)	조임토크 (Torque)
YS FT030-03	∅8.0	67	35	13	26	10.3	4.0	54.5	1.5~4mm ² (16~12AWG)	M4.5	18kgf·cm
YS FT030-04		79						68.0			
YS FT030-06		102.5						91.0			
YS FT030-10		156						144.5			

60A



CE

형식(TYPE)	N(min)	L	W	I	H	P	∅ (min.)	M	적용적합전선 (Suitable Wire(max.))	단자볼트 (Terminal Bolt)	조임토크 (Torque)
YS FT060-03	∅7.5	83.5	41	20	32.5	15.5	5.0	27.5	6~16mm ² (10~6AWG)	M6.0	25kgf·cm
YS FT060-04		111						55.0			

100A



형식(TYPE)	N(min)	L	W	I	H	P	∅ (min.)	M	적용적합전선 (Suitable Wire(max.))	단자볼트 (Terminal Bolt)	조임토크 (Torque)
YS FT100-03	∅11.5	105.5	55.5	23	38	23	5.0	34.8	25~50mm ² (4~0AWG)	M8.0	60kgf·cm
YS FT100-04		140					6.0	69.6			

150A



형식(TYPE)	N(min)	L	W	I	H	P	∅ (min.)	M	적용적합전선 (Suitable Wire(max.))	단자볼트 (Terminal Bolt)	조임토크 (Torque)
YS FT150-03	∅11.5	116	67.5	26	43	26	7.0	38.8	35~70mm ² (2~00AWG)	M8.0	60kgf·cm
YS FT150-04		154.8					7.2	77.2			

200A

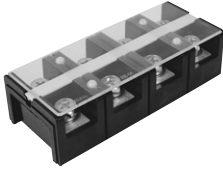

형식(TYPE)	N(min)	L	W	I	H	P	∅ (min.)	M	적용적합전선 (Suitable Wire(max.))	단자볼트 (Terminal Bolt)	조임토크 (Torque)
YS FT200-03	∅11.5	134.8	73	29.5	46.5	29	6.5	45	70 ~ 120mm ² (00 AWG ~ 250kcmil)	M10.0	100kgf·cm
YS FT200-04		180									

300A

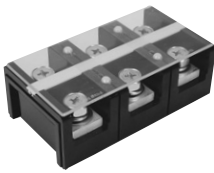

형식(TYPE)	N(min)	L	W	I	H	P	∅ (min.)	M	적용적합전선 (Suitable Wire(max.))	단자볼트 (Terminal Bolt)	조임토크 (Torque)
YS FT300-03	∅12.5	155.5	83	33.5	49.4	33.7	8.0	51.5	120 ~ 185mm ² (250 ~ 350kcmil)	M12.0	140kgf·cm
YS FT300-04		207									

400A

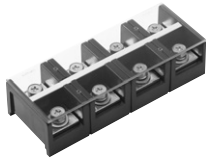

형식(TYPE)	N(min)	L	W	I	H	P	∅ (min.)	M	적용적합전선 (Suitable Wire(max.))	단자볼트 (Terminal Bolt)	조임토크 (Torque)
YS FT400-03	∅12.5	163.0	90	33.5	50	34.0	8.4	55.0	120 ~ 185mm ² (250 ~ 350kcmil)	M12.0	140kgf·cm
YS FT400-04		218.0									

500A



형식(TYPE)	N(min)	L	W	I	H	P	∅ (min.)	M	적용적합전선 (Suitable Wire(max.))	단자볼트 (Terminal Bolt)	조임토크 (Torque)
YS FT500-03	∅12.5	193.0	99	43.5	60	43	8.4	65.5	185 ~ 300mm ² (350 ~ 600kcmil)	M12.0	140kgf·cm
YS FT500-04		258.5									

600A



형식(TYPE)	N(min)	L	W	I	H	P	∅ (min.)	M	적용적합전선 (Suitable Wire(max.))	단자볼트 (Terminal Bolt)	조임토크 (Torque)
YS FT600-03	∅12.5	193.0	99	43.5	60	43	8.4	65.5	185 ~ 300mm ² (350 ~ 600kcmil)	M12.0	140kgf·cm
YS FT600-04		258.5									